

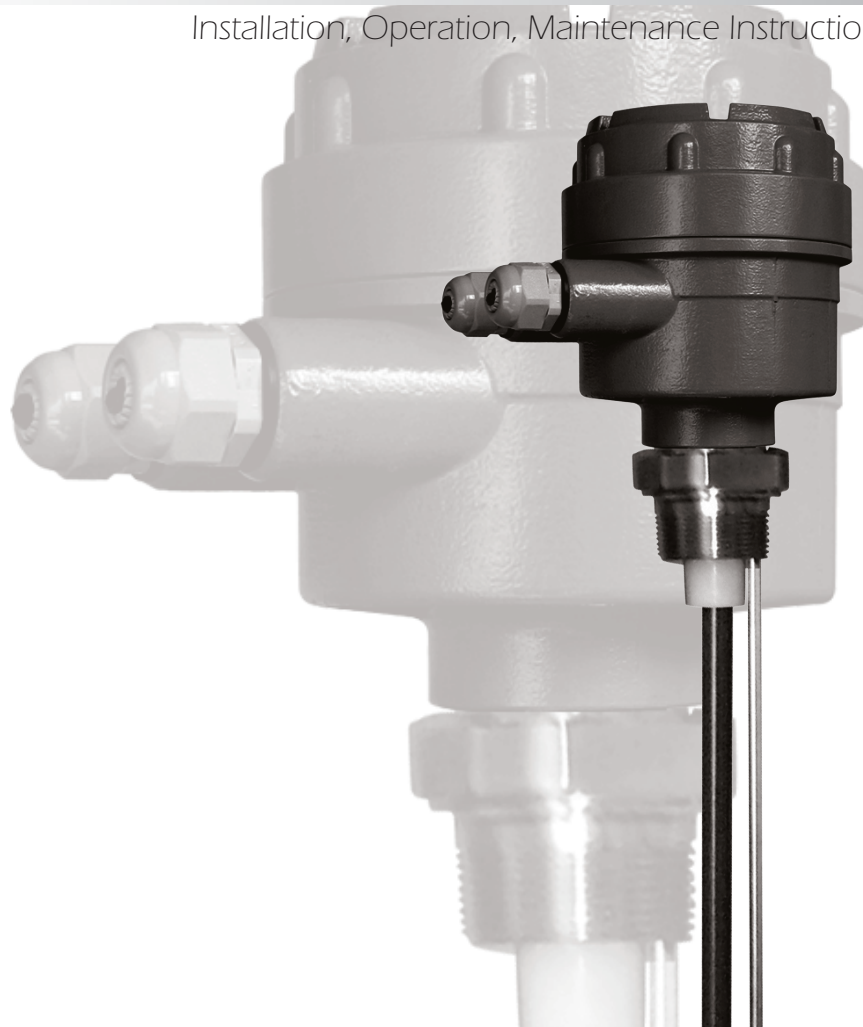

## USER'S GUIDE

Installation, Operation, Maintenance Instructions



**SC404**

Capacitive  
Level Sensor

## Contents

Introduction . . . . .	4
Models & Dimensions . . . . .	5
Wiring Diagram . . . . .	6
Mounting Note . . . . .	12
Installation . . . . .	13
Calibration . . . . .	17
Handling . . . . .	19
Technical Specifications . . . . .	20
Trouble Shooting . . . . .	21
Ordering Information . . . . .	22
Terms & Conditions . . . . .	23

## SC404 - Capacitive Level Sensor

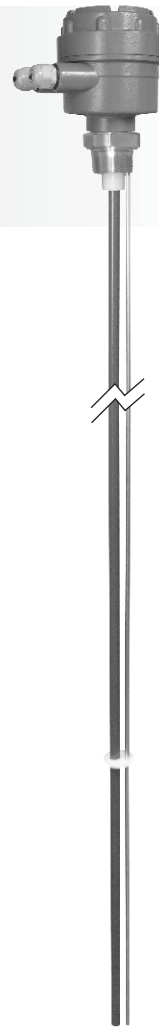

The SC404 is a capacitance continuous level transmitter with an integrated electronics module mounted within the housing. This 2 wire loop powered unit provides a 4-20mA output (galvanically isolated). Set up and calibration is achieved with a zero and span adjustment which works best when starting with an empty tank to set the zero and then filling it to set the span. This flexible level measurement device works well in many industrial processes and process media including a variety of liquids, powders and pastes. The SC404 is made with 316SS rigid rods or 316SS cables (coatings are required for conductive mediums) and can also be made with a secondary reference rod or reference sheath built into the process connection.

The wide range of applications for RF analog level measurement probes (such as liquids, pastes, solids and granules), requires attention in selecting the correct configuration and installing it in the proper location. To cater to all applications, Sitron's probes are offered with different designs and features.

### Features

- Wide range of applications/industries:  
i.e. water, oils, corrosives, solids, powders, grains, etc.
- Accurate and reliable measurement
- No moving parts - Rugged construction
- Can operate at high temperatures and pressure
- Functions on conductive as well as non-conductive medias
- Galvanic Isolation

## Models and Dimensions

### Housing Types

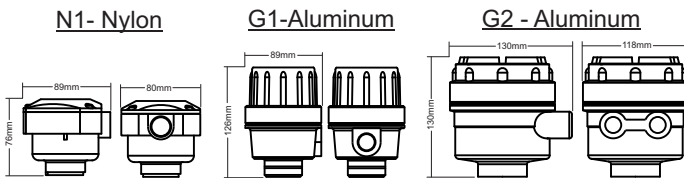

### Mounting Options for SC404



Extended necks for medium temperature (up to 120°C)

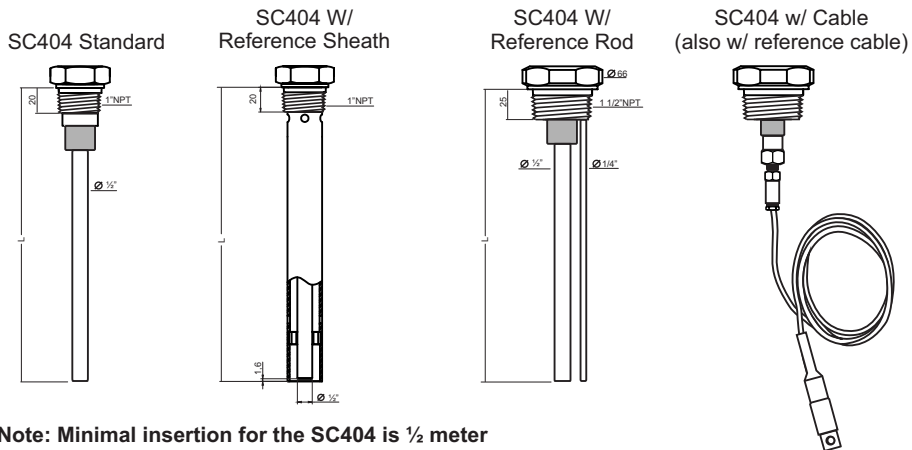

Note: Minimal insertion for the SC404 is 1/2 meter

### Process Connections

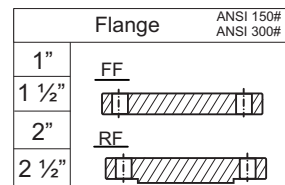
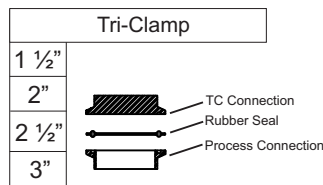
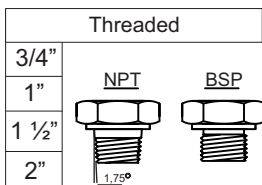

## Wiring Diagram

### SC404 with N1 Housing

- A- Adjust Sensibility (Gain)
- B- Adjust Sensibility (Sub gain)
- C- Adjust Zero (begin scale)
- D- Adjust Span (end of scale)

- 1- Power Supply (+) 24Vdc / 4...20mA
- 2- Power Supply (-)
- 3- Ground

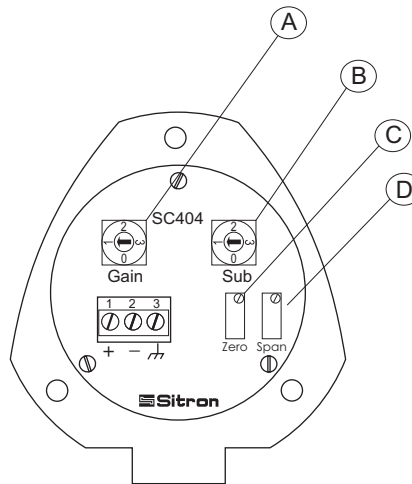

### SC404 with G1 Housing

- A- Adjust Sensibility (Gain)
- B- Adjust Sensibility (Sub gain)
- C- Adjust Zero (begin scale)
- D- Adjust Span (end of scale)

- 1- Power Supply (+) 24Vdc / 4...20mA
- 2- Power Supply (-)
- 3- Ground

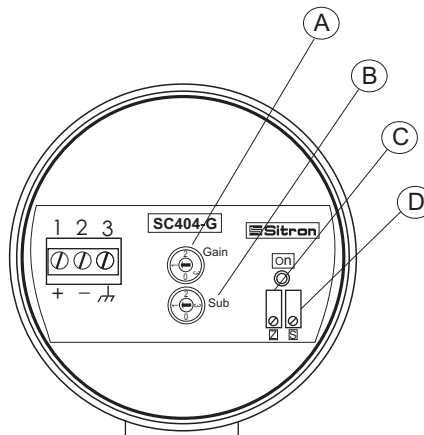

## Wiring Diagram

### SC404 with G2

- A- Adjust Sensibility (Gain)
- B- Adjust Sensibility (Sub gain)
- C- Adjust Zero (begin scale)
- D- Adjust Span (end of scale)

- 1- Power Supply (+) 24Vdc / 4...20mA
- 2- Power Supply (-) 24Vdc / 4...20mA
- 3- Ground

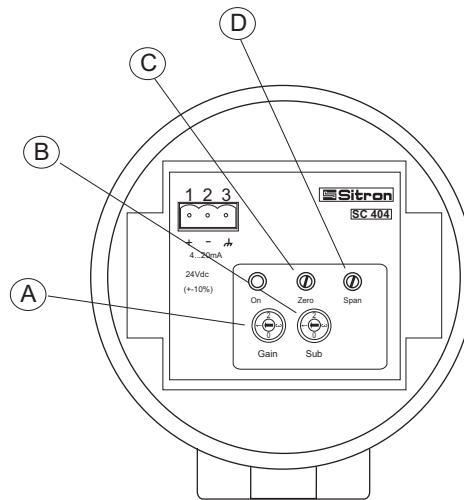

# Wiring Diagram

## Galvanic Isolator - ISO420

- 1- Probe (+)
- 2- Probe(-)
- 11- Power Supply (+)
- 12- Power Supply (-)

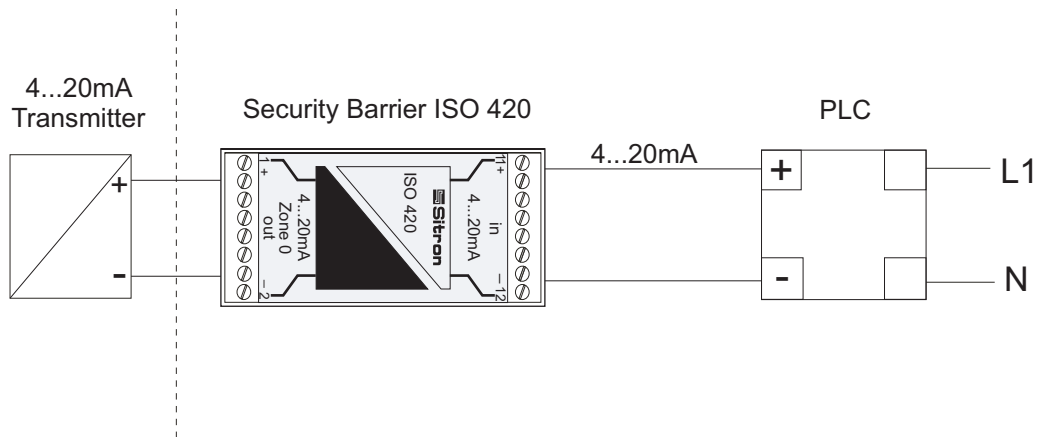
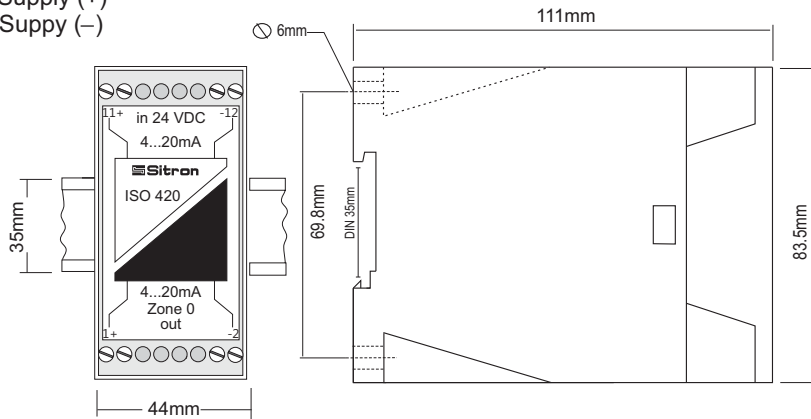

# Wiring Diagram

## Different wiring scenarios for the N1 electronics

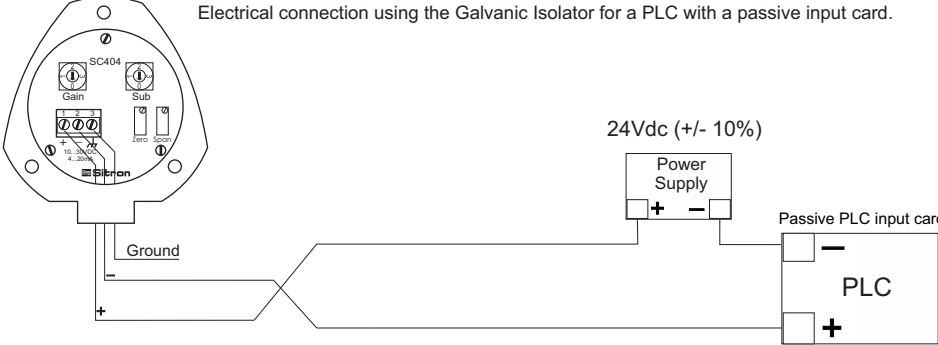
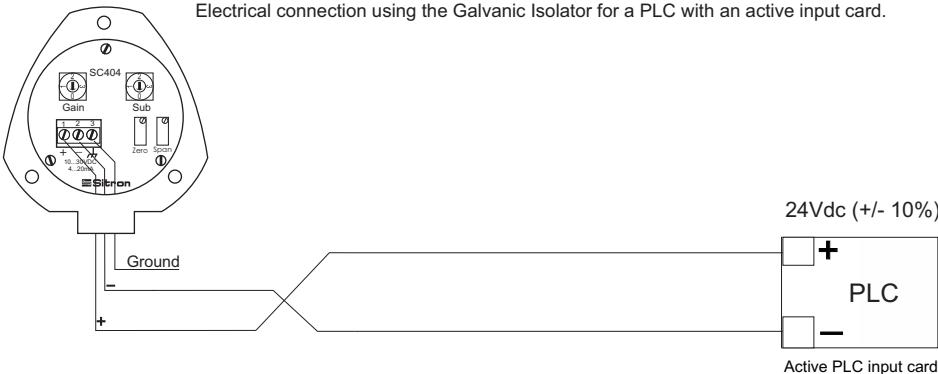
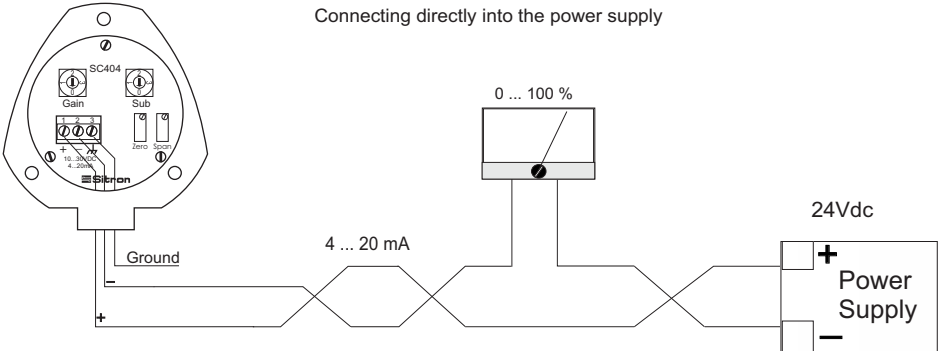



Wiring Diagram

Different wiring scenarios for the G1 electronics

Connecting directly into the power supply

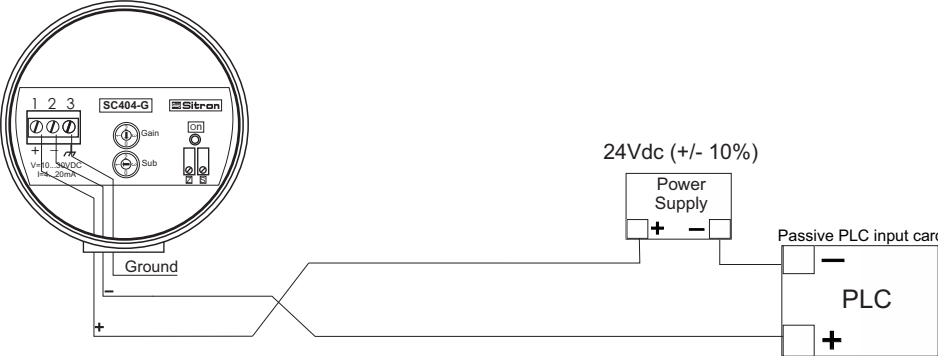
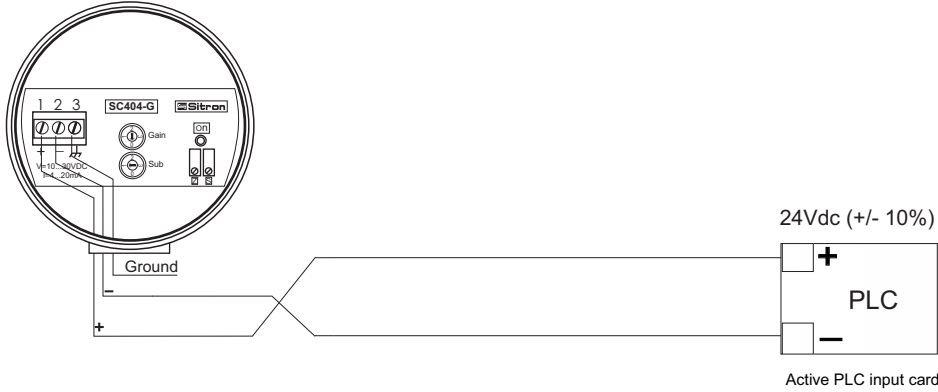
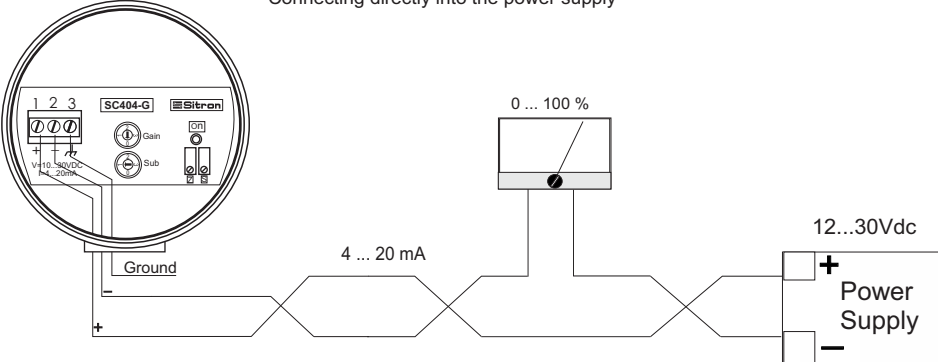

# Wiring Diagram

## Different wiring scenarios for the G2 electronics

The G2 offers a built-in galvanic isolator. In this case a separate one is not necessary.

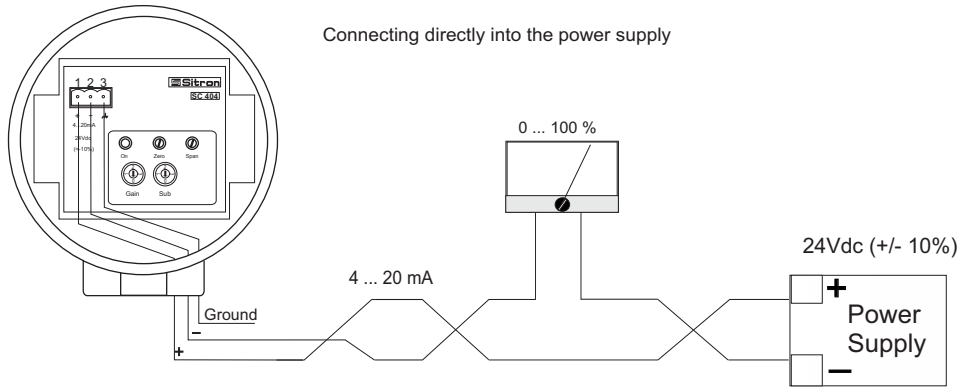

Electrical connection for a PLC with an active input card.

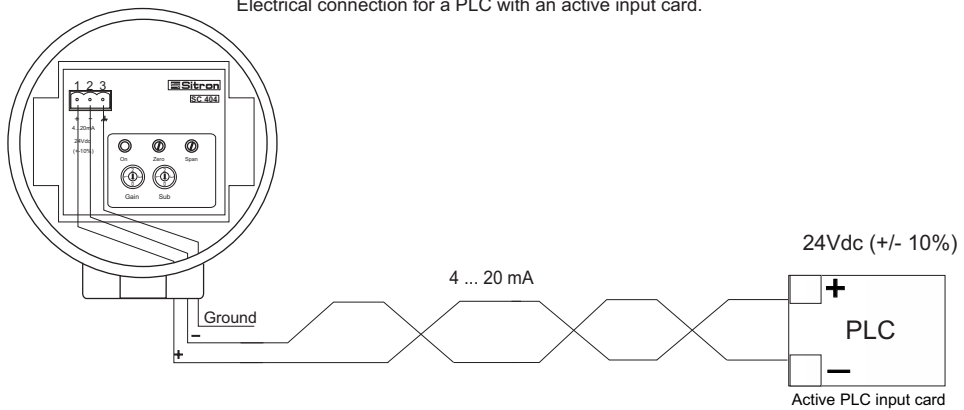

Electrical connection for a PLC with a passive input card.

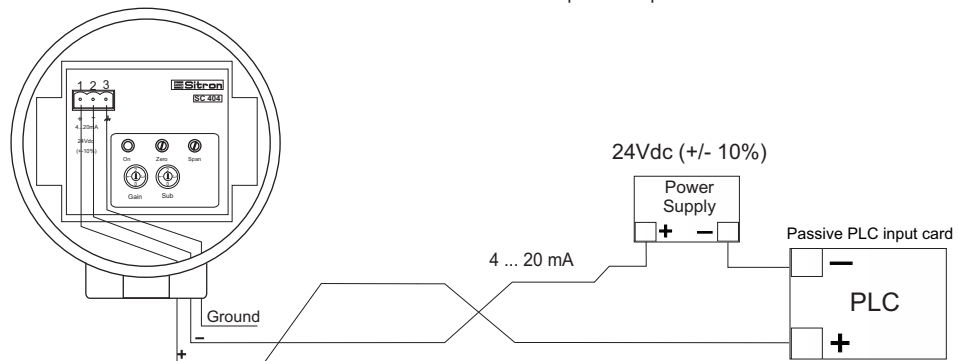

## Mounting Note

Materials that are conductive will cause a short circuit between a bare stainless steel probe and the tank wall. For that reason we recommend the use of Teflon or other types of insulating coatings on the rod's surface (Fig. 1)

Material build-up also affects the accuracy of RF capacitive measurements, and therefore additional adjustment to the probe's sensitivity is recommended in applications where build-up is a concern (Fig. 2)

Housings must also be compatible with the requirements for wash-down, wet, and/or dusty environments. Hazardous environments may require the housing to be certified. In addition, the active probe might need to be intrinsically safe or have an intrinsic safety barrier (Fig. 3).

The electronic circuitry of the probe performs several functions such as rectifying and filtering the incoming power, generating the radio frequency signal, measuring the changes in current flow, analog signal generators and display meters. The circuitry is provided with potentiometer adjustments for setting sensitivity that is located in the housing of the probe. These adjustments give an added level of fine-tuning which enable our customers to control the probe's sensitivity with greater accuracy (Fig. 3).

Variation in current input (power supply) to the probe will affect the output. Therefore, a stable power supply should be available (Fig. 4).

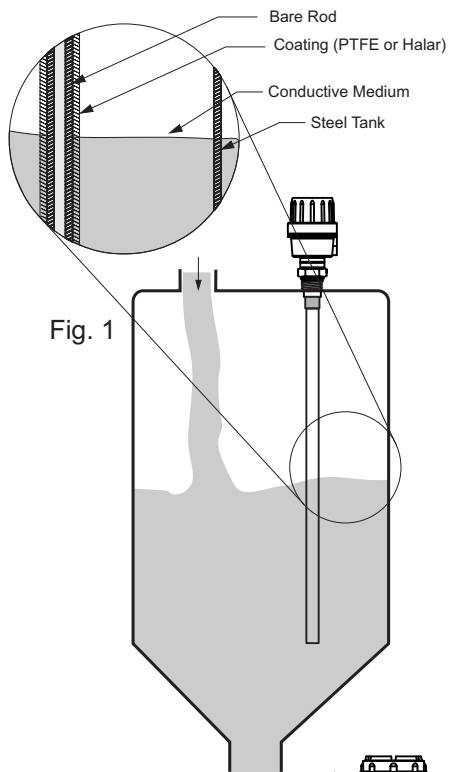

Fig. 1

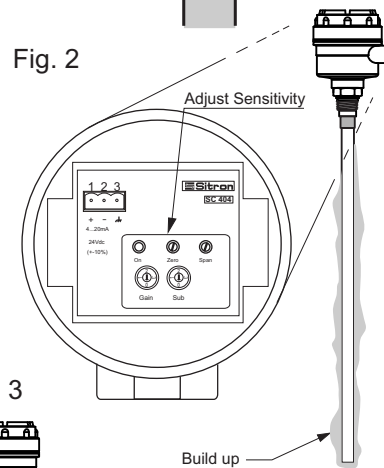

Fig. 2

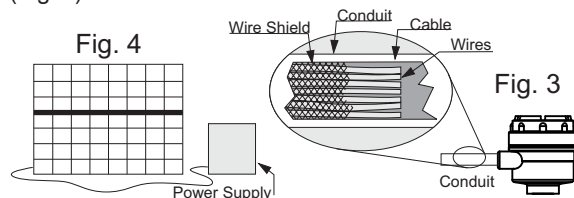

Fig. 4

Fig. 3

## Installation

When installing the probe either directly to the tank, or utilizing a connection, the capacitance probe should be mounted on the top of the tank, never on the side or angle, so that the rod stays parallel to the tank wall (Fig. 1 correct Fig. 2 Incorrect).

The mounting location of the probe should stay clear away from the point where the medium enters, this will avoid false reading from the sensor while being filled (Fig. 1 correct Fig. 2 Incorrect).

The recommended distance of installation of the probe from the internal wall is a minimum of 500mm, and from the tip of the rod to the bottom of the tank is 100mm, this will prevent a false signal and possible build up between the wall and probe (Fig. 1 correct Fig. 2 Incorrect).

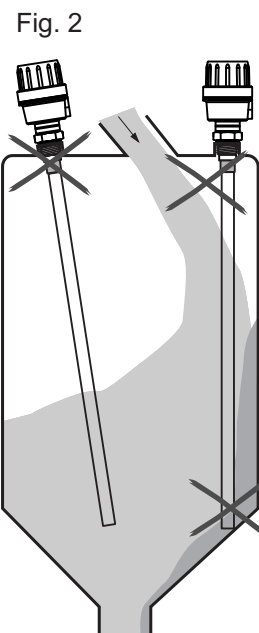
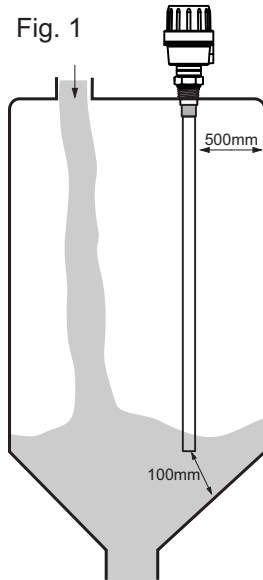

## Installation

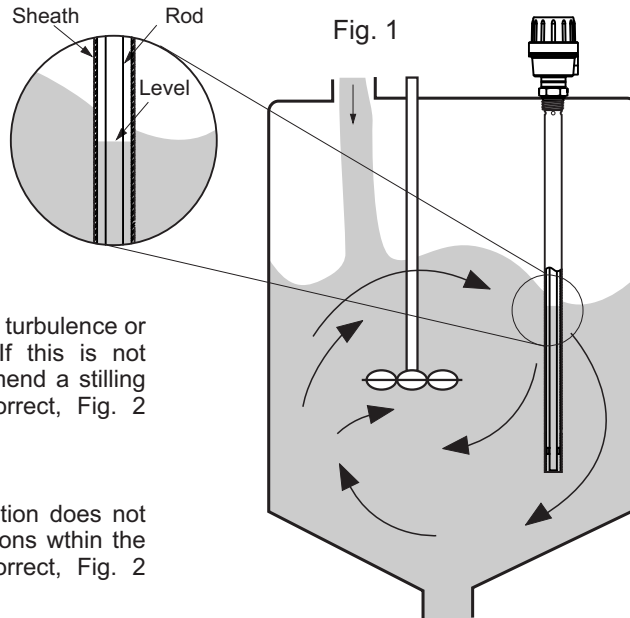

The tank must be free from turbulence or vortices throughout use. If this is not possible we highly recommend a stilling well or sheath (Fig. 1 correct, Fig. 2 incorrect).

Ensure that mounting position does not interfere with any obstructions within the vessel or tank (Fig. 1 correct, Fig. 2 incorrect).

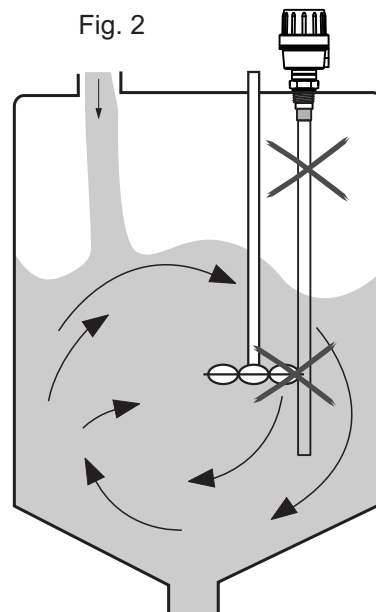
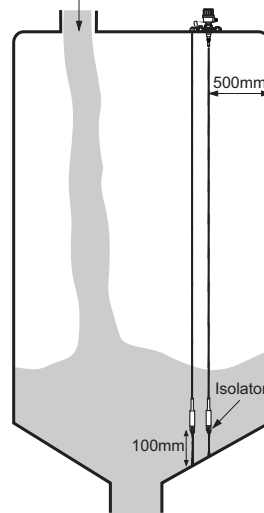

Fig. 1



When installing the SC404 with cable and reference be sure that they are well connected to the bottom of the tank and that it has no slack. (Fig. 1 correct Fig. 2 Incorrect).

The mounting location of the probe should stay clear away from the point where the medium enters, this will avoid false reading from the sensor while being filled (Fig. 1 correct Fig. 2 Incorrect).

The recommended distance of installation of the probe from the internal wall is a minimum of 500mm, and from the tip of the pendulum to the bottom of the tank is 100mm, this will prevent a false signal and possible build up between the wall and probe (Fig. 1 correct Fig. 2 Incorrect).

If the cable is secure to the bottom of the vessel it must be isolated and the vessel is steel it must be isolated so that it does not create a short circuit.

Fig. 2

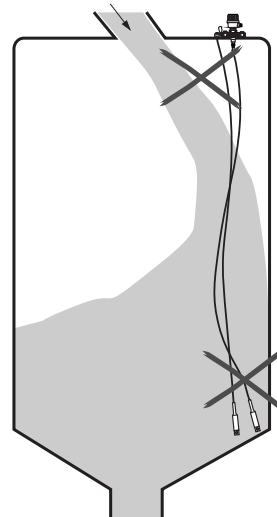

# Installation

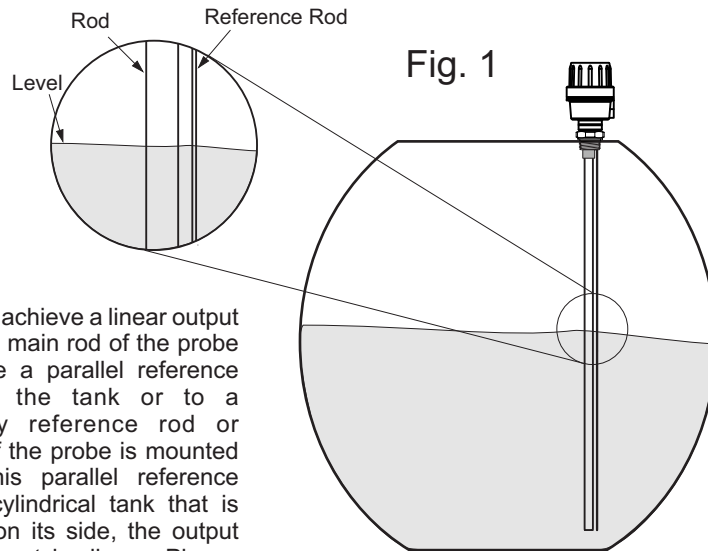

In order to achieve a linear output signal, the main rod of the probe must have a parallel reference either to the tank or to a secondary reference rod or sheath. If the probe is mounted without this parallel reference within a cylindrical tank that is mounted on its side, the output signal will not be linear. Please consult one of our applications engineers if you have further questions (Fig.1 correct Fig. 2 incorrect).

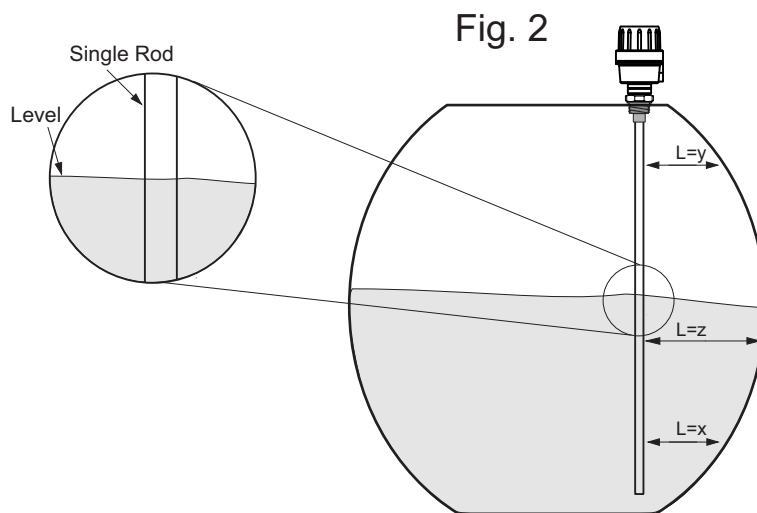

## Adjustment (4-20mA):

It is recommended that a multimeter be connected according to the figure below (fig.5) to monitor the current value during the calibration.

- 1) Drain the tank to minimum level (Zero% or 4mA).
- 2) Select the Gain switch 1,2,3 and Sub positions 1,2 or 3. It is recommended to begin with Gain switch 1 and Sub position 1 (Fig. 2).

3) Use the Zero potentiometer to set the current value for the actual level to 4mA. Turn the potentiometer clockwise to increase current. Turn the potentiometer counter-clockwise to decrease current (If the adjustment wasn't possible, alter the Sub and Gain position and try in adjust the minimum value (4mA) through the Zero Potentiometer)(Fig.3)

4) After calibrating the minimum value (4mA), fill up the tank to maximum level (100% - level).

5) The Sub and Gain switches should be in the same position as adjusted to 4mA.

6) Use the Span potentiometer to set the current value for the actual level to 20mA. Turn the potentiometer clockwise to increase current. Turn the potentiometer counter-clockwise to decrease current (Fig.4).

7) If the current is lower than 20mA after fully turning the Span Potentiometer clockwise, it is necessary to increase the sensitivity by selecting the next level of the switch (Sub and Gain). If the current still remains lower than 20mA, continue on to the next level until you achieve 20mA.

8) With the 20mA signal adjusted it is best to re-adjust the Zero. Drain the tank back down to the starting level and re-adjust (if necessary) the minimum level to 4mA one more time. After this stage, set-up is complete.

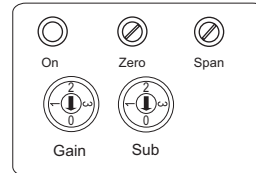

Fig.2

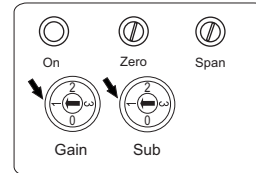

Fig.3

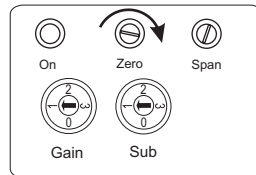

Fig.4

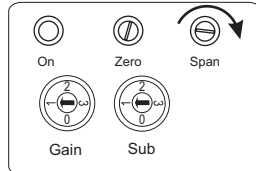
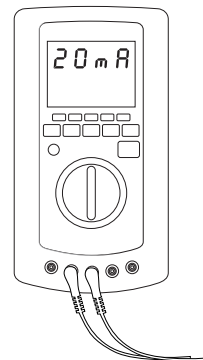

Fig.5





## Calibration

The dielectric value varies according to the product, temperature, pressure, rod's length and shape of the tank. Because of these variations, the parameters of the capacitive probe need to be adjusted according to each application as well as each tank. While the SC404 can be tested on a bench, the results of calibrating it will not be the same as calibrating the unit within the actual tank that you plan on installing it in.

### Nylon-N1

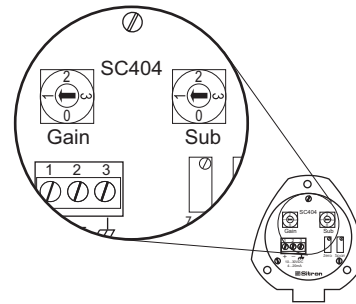

### Aluminum-G1

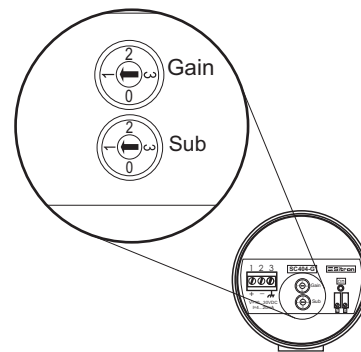

The SC 404 has 3 stages of sensitivity and that can be adjusted by a selective switch. Each stage has 3 subdivisions (1, 2, 3) for the SC404 and 4 subdivisions (1, 2, 3, 4) for the SC404-G to be combined with the selective switch. Check the values on the chart below according to your application.

Capacitive Range for the SC404-G:

<b>Gain</b>	<b>Sub</b>
1) 1600pF to 5500pF	1 - 3750 to 5500pF 2 - 2500 to 3750pF 3 - 1600 to 2500pF
2) 400pF to 1500pF	1 - 900 to 1500pF 2 - 600 to 900pF 3 - 400 to 600pF
3) 100pF to 330pF	1 - 225 to 330pF 2 - 150 to 225pF 3 - 100 to 150pF
4) 25pF to 150pF	1 - 150 to 100pF 2 - 100 to 70pF 3 - 70 to 25pF

### Aluminum-G2

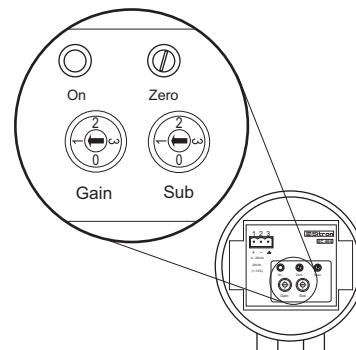

## Handling

### Probes:

Seal the thread with Teflon tape before installation (Fig. 1).

Fig. 1

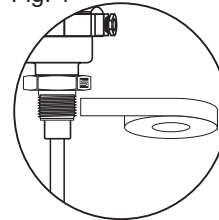

Do not turn or handle by the housing (Fig. 2).

Fig. 2

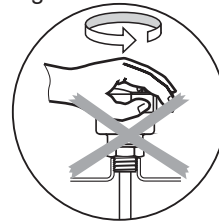

When tightening the sensor, use only use the 316S.S. hexagon fitting to achieve a seal, do not twist with the body of the sensor. (Fig. 3)

Fig. 3

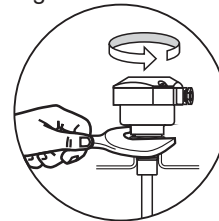

The probe should not be dropped or suffer any impact or fall that could damage the electronics or the coating of the probe (Fig. 4 and 5).

Periodic visual inspection of the probe is required to check for corrosion or deposit build-up. If deposits are found, clean the sensor to ensure optimum performance.

Fig. 4

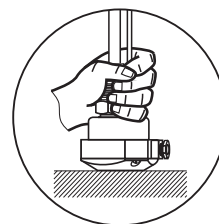

Care should be taken when handling and installing probes with coated rods to avoid scratching them. Scratching the coating could interfere with the probe performance.

Fig. 5

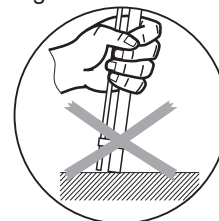

When cleaning the rod use a soft brush or any other similar object.

## Technical Specifications

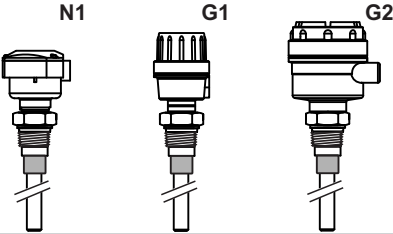
SC404	
	
Application	Continuous Level Measurement for Liquids and Solids
Operating Voltage	24Vdc (+/- 10%)
Current Consumption	22mA max
Adjustment	Zero & Span Potentiometer
Sensitivity Range	100 to 5500pF
Frequency Oscillation	400 kHz
Output	4...20mA (2 wires)
Accuracy	0.5%
Galvanic Isolation	3KVdc/60s 100M ohms, 500VDC
Electrical Connection	Cable gland - 1/2" NPT conduit entry or M12 connector
Process Connection	3/4" to 1 1/2" BSP or NPT Flange or Sanitary Connections
Wetted Parts	316 Stainless Steel, PTFE
Enclosure Material	Glass filled nylon, Aluminum
Max Pressure	290 PSI (20 Bar)
Ambient / Operating temp.	-10 to 60°C / -10 to 80°C (120°C extended neck)
Class Protection	IP 65 (N1) IP66 (G1/G2)

## Trouble Shooting

Fault	Cause	Solution
No signal	No power supply	Verify power supply
	Inadaquate connection	Verify the polarity of the power supply
Signal over 22mA	Probable short circuit	Verify that the rod is coated for conductive mediums
	Sensitivity to high	Adjust sensibility again
Signal Fluctuating	Lack of signal from referance rod	Verify the grounding
Signal under 20mA	Sensitivity to low	Adjust sensibility again
Lack of linearity	Reference is incorrect	Add a Reference
		Sheath the rod
	Coating on the rod is damaged	Send back for repair

# Ordering Information

<b>MODEL</b>	
SC404	
<b>SIZE</b>	
4	3/4"
5	1"
6	1 1/2"
7	2"
9	3"
Q	4"
X	OTHER
<b>PROCESS CONNECTION TYPE</b>	
B	BSP
D	FLANGE ANSI 150# CARBON STEEL PAINTED
E	FLANGE ANSI 150# 316 SS
F	FLANGE ANSI 150# PVC
K	FLANGE ANSI 150# 304 SS
N	NPT
T	TRI-CLAMP
X	OTHER-SPECIFY
<b>TYPE OF ROD OR CABLE</b>	
R	RIGID ROD-1/2"(12.7mm) or 5/8"(16mm)-316SS
RR	RIGID ROD+REFERENCE ROD-1/2"(12.7mm) or 1/4"(6.3mm)-316SS
M	STEEL CABLE-6.0mm
C	ROD (1/2") and SHEATH 316SS
<b>COATING</b>	
S	NONE
H	HALAR COATED
T	PTFE TUBED
X	OTHER-SPECIFY
<b>INSERTION LENGTH</b>	
L	SPECIFY
<b>HOUSING</b>	
N1	SMALL NYLON
G1	SMALL ALUMINIUM
G2	LARGE ALUMINIUM
<b>ELECTRICAL CONNECTION</b>	
1	1/2" BSP
2	CABLE GLAND W/ 1/2" BSP
4	3/4" BSP
5	CABLE GLAND W/ 3/4" BSP
6	1/2" NPT
7	CABLE GLAND W/ 1/2" NPT
9	3/4" NPT
C	CABLE GLAND W/ 3/4" NPT
<b>OPTIONS</b>	
MT	Medium Temp - 50mm 316SS Neck (80-120C)

## Terms & Conditions

### Sitron's TERMS & CONDITIONS

**Design:** Sitron reserves the right to make any alterations or changes necessary to improve the Products, correct defects or to make the Products safer, without prior notice or consent by Buyer.

**Pricing:** All stipulated amounts shall be in US dollars and all prices quoted are valid for thirty (30) days from date of offer, unless otherwise stated.

**Safety and Instructions:** The Buyer ensures that it and all its representatives and agents will observe all safety and technical instructions in Sitron's operating manuals, catalogs or other directions or instructions (either written or verbal).

**Delivery and Freight:** All goods are sold FOB point of shipment, Brasil. Transportation to the destination is the Buyer's responsibility and Buyer alone shall bear the cost of freight, optional or other shipping requirements, and or insurance. Sitron shall not be liable for loss or damage to the Products after said Products are delivered to or received by the shipper/carrier, and all risk of damage or loss shall immediately pass to Buyer.

Receiving, unloading and storing of Products will be the responsibility of the Buyer.

Buyer also accepts that courier may choose to return Products to Sitron if any local taxes or duties are not paid by Buyer at point of delivery. Buyer must make any and all claims for corrections or deductions within ten days of the delivery of the Products.

**Shipment Delays:** Sitron has no control over the length of time shipments may be held at customs, etc. For this reason, Sitron commits only to a "shipment date", not a "delivery date". Buyer shall not hold Sitron liable for claims resulting from delay in shipment except in cases where these terms are accepted in writing by Sitron. Acceptance of delivery of Products by Buyer shall constitute a waiver of all claims for delay.

**Partial Deliveries:** While Sitron strives to deliver all orders on time and complete, Sitron reserves the right to make partial deliveries when necessary.

**Changes:** Any changes initiated by the Buyer which affects the products specifications; quantities ordered; delivery schedule; method of shipment or packing; or delivery location, must be made in writing and signed by both parties.

In this case, Sitron reserves the right to adjust the pricing and or delivery of the order, which will be agreed to by both parties before further work is performed on the order. Any such requests will be priced according to the scope of changes and the status of the current order. Customer must sign and return or acknowledge approval of drawings along with any Purchase Order. If approval drawings are not returned with order, the delivery date may be held or pushed back until Customer has acknowledged approval.

**Cancellation:** Any cancellation of the Contract by the Buyer shall be effective only if made in writing and accepted, in writing by the Sitron. In such a case, Sitron is entitled to reasonable cancellation charges including but not limited to labor, material and other related expenses.

## Terms & Conditions

**Termination Fee Schedule:**

Order entered but not released for manufacturing	10%
Order in any stage of production	75%
Order complete and ready for shipment	100%

**Warranty:** Sitron warrants its product against manufacturing defects in material and workmanship, when installed in applications approved by Sitron, for a period of one year from the date of original shipment, unless otherwise stated in writing by Sitron.

Sitron is not responsible for damage to Sitron's Products or other equipment or products because of improper installation or misapplication of the Products by Buyer. Installation or startup of Sitron's equipment must be performed under the guidelines set forth in Sitron's instruction manuals, wiring diagrams, etc., or performed under the direct supervision of Sitron's field technicians or Sitron's authorized Sales Representatives, in order to be covered by Sitron's warranty.

Sitron shall be under no liability in respect to any defect from fair wear and tear, willful damage, negligence, abnormal working conditions, failure to follow Sitron's instructions (whether written or verbal), misuse, modification or alteration or attempted repair of the Goods without Sitron's approval.

Sitron shall not be liable under the above warranty (or any other warranty, condition or guarantee) if the total price for the Products or the payment of Services rendered has not been paid by the due date for payment.

The Buyer must make all tools, resources or personnel available to help Sitron to diagnose the defect without any back charge. In absence of Buyer's cooperation in this regard, there shall be no liability under the above Warranty.

Sitron's liability under this warranty shall be limited to repair or replacement at Sitron's option of such defective Products, FOB factory, upon proof of defect satisfactory to Sitron. Warranty does not include transport.

**Return Goods:** No goods may be returned without Sitron's permission and an RMA number. Sitron assumes no responsibility for return shipments made without permission. In issuing credit for such shipments, Sitron reserves the right to charge a restocking fee dependent on Sitron's ability to recondition and resell the returned equipment.

**Insurance:** The responsibility for insuring the Goods after the risk in them has passed to the Buyer shall be that of the Buyer.

**Confidential Information:** All drawings, specifications, and technical information provided by either Buyer or Sitron shall be treated as confidential and shall not be disclosed to anyone other than those who require it as part of the fulfillment of the order. Buyer agrees that the designs and/or any other related material provided are and remain Sitron's exclusive property and that the Buyer acquires no right, title or interest to this intellectual property, whether in whole or in part.

**Errors:** Sitron reserves the right to correct all typographical or clerical errors or omissions, in its prices or specifications.



10\_2019 rev 0

Sitron - Brasil  
R. Baronesa de Itu, 83  
São Paulo - SP - 01231-001  
T: (5511) 3825-2111  
F: (5511) 3825-2171

Sitron - USA  
1800 Prime Place  
Hauppauge, NY 11788  
PH: 516-935-8001  
FX: 800-516-1656

[www.sitron.com](http://www.sitron.com)  
BRASIL: [vendas@sitron.com](mailto:vendas@sitron.com)  
USA / Other Countries: [info@sitron.com](mailto:info@sitron.com)