



User's Guide

Installation, Operation and Maintenance



EL Series

Conductive Level Switch

Contents

Introduction	3
Models	4
Models & Dimensions	5
Models & Connections	7
Mounting Notes	14
Installation	15
Technical Specifications	18
Handling & Maintenance	24
Trouble Shooting	25
Ordering Information	26
Terms & Conditions	28

EL Series Conductive Level Switch

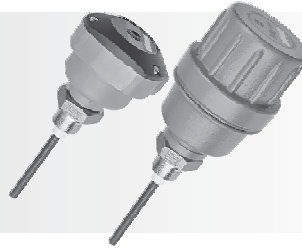

Sitron's EL Series of Conductive Level Switches are designed to control the level of all conductive media with up to six different points of level control. These probes can be applied when multiple points of level detection are required from a single entry point on the vessel. These units work in combination with Sitron's BS and CN Series of Relay level controllers which offer multiple configurations to meet the needs of a wide array of process applications.

Models are available with rigid rods, removable rods and pendular electrodes made from 316SS. For applications with aggressive or sticky media or higher temperatures, the rods may be coated with Epoxy or Halar. The EL Series Level Switches are designed to work at temperatures of -10° to 150°C and maximum pressures of up to 20 bar.

Technology:

The probes work by the change in electrical resistance between the sensing electrode and the reference electrode or metal wall of the vessel. When the electrode comes into contact with the conductive medium the electronics detects the change in resistance which actuates the relay output. The electrodes are powered up with alternating current. The use of alternating current prevents the corrosive result of electrolysis on the rods.

The EL Sitron series should be used in conjunction with Sitron's BS and CN Series of level controllers.

Features

- Can operate in all conductive liquids media;
- Easy to install and operate;
- Offers several level control points;
- Optional Epoxy or Halar coated rods for aggressive medium;
- Up to 5 points of level control
- Available with 316SS, sanitary, flange or threaded connections;

Models

EL
N1 HOUSING

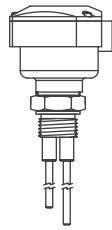

EL
N1 HOUSING

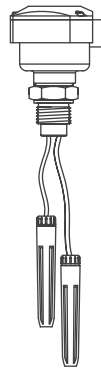

THC
316SS HOUSING

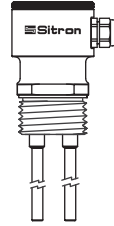

TA 01



EL
G1 HOUSING

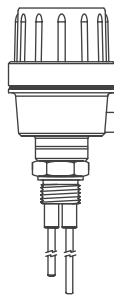

EL
G1 HOUSING

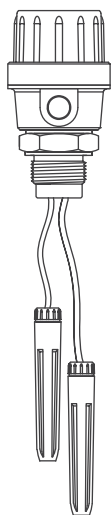

EL REMOVABLE ROD
G1 HOUSING

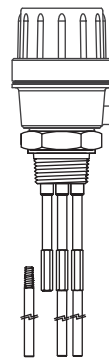

ER 02

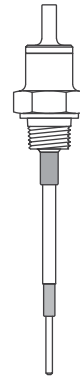

Models & Dimensions

Mounting Option

Stainless Steel-THC

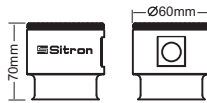

N1-Nylon

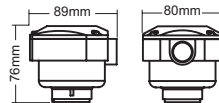

G1-Aluminum

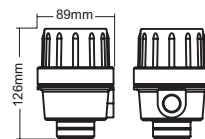

Insertion Length

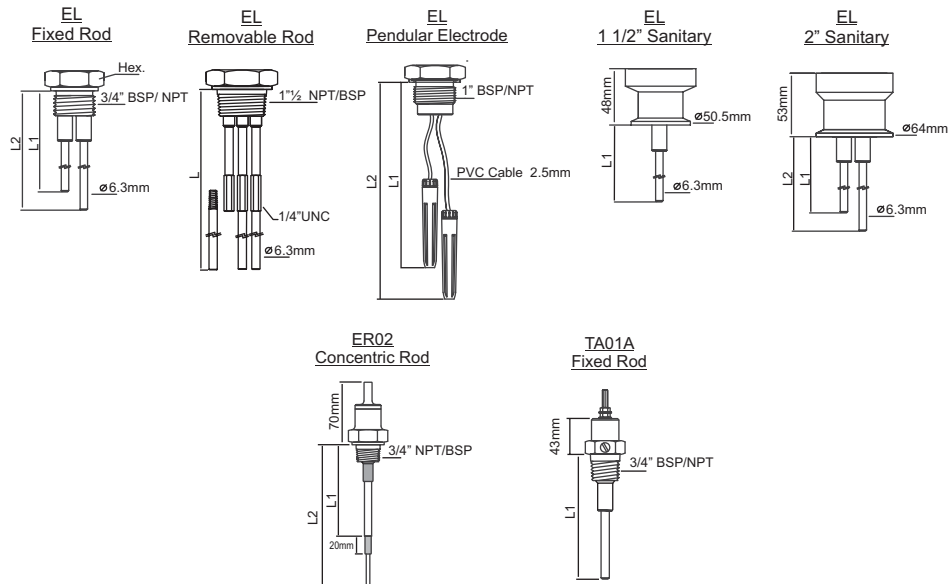

The EL series can be made with up to 6 Rods or Pendular electrodes.

Process Connections

Threaded Connections	
3/4"	
1"	
1 1/2"	
2"	

Tri-Clamp Connection	
1 1/2"	
2"	
2 1/2"	
3"	

Flange Connections	
1"	ANSI 150# ANSI 300#
1 1/2"	FF
2"	RF
2 1/2"	

Models & Dimensions

Relay Controller Models

BS16-Differential Controller Relay

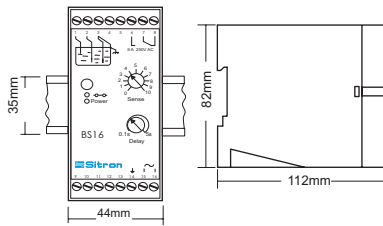

BS40-Differential Controller Relay

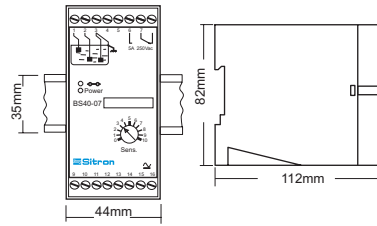

CN16-Control of 2 Independent Level Points

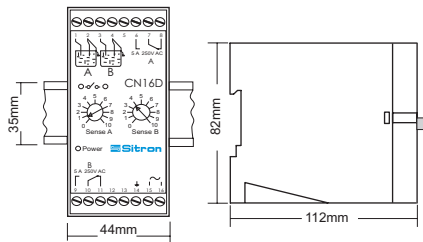

CN7- Control of 3 Independent Level Points

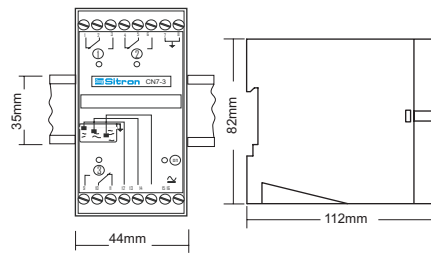

CLD2-Amplifier Control

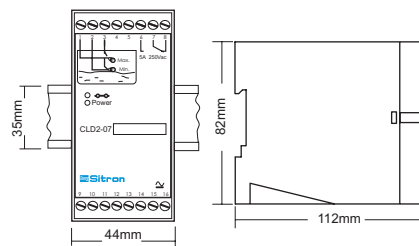

Models & Connections

EL (1~6) - Pendular electrodes

Can accommodate up to six electrodes and are ideal for applications such as deep wells, tanks or water tanks, where the use of long fixed rods is not practical. The electrodes are supported by PVC cables, which allow for much longer lengths than fixed or removable rods, facilitating both installation, handling and transportation.

Nylon-N1 Aluminum-G1

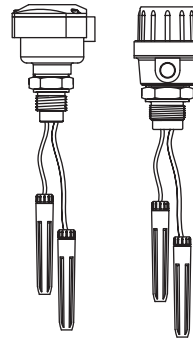

Connections

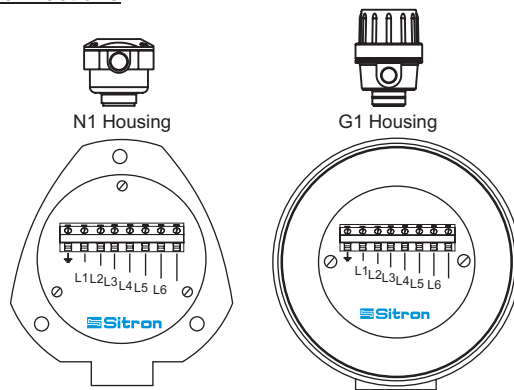

L1 to L6: Insertion length

ER02 - Concentric rod

Appropriate for control of minimum and maximum level. The main feature of this model is that it is ideal for narrow containers. This unit is easy to mount, does not have a housing enclosure, and comes with a direct electrical connection via PVC cable. The ER02 offers 316 stainless steel threaded connections.

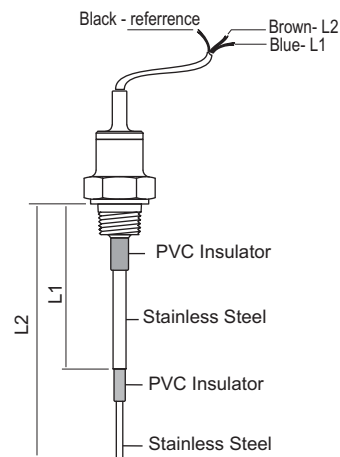

L1~L2: Insertion length

Models & Connections

EL (1~6) - Fixed Rods

Used for level control, this model can accommodate up to six fixed rods, made of 316 stainless steel, for up to 6 different points of level control. It is available with either a nylon, aluminum or stainless steel housing.

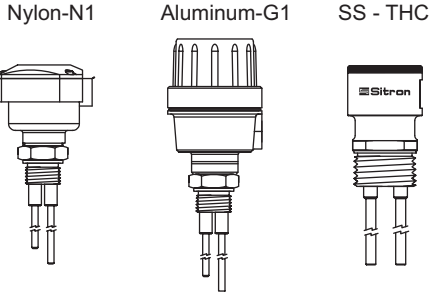

Connections

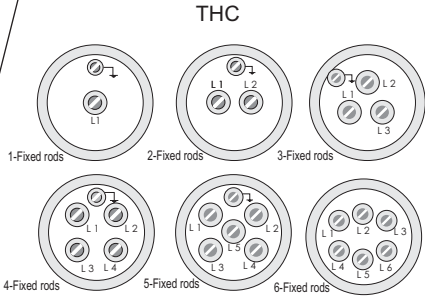
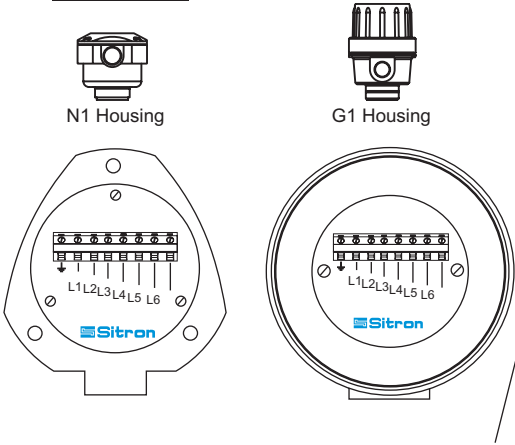

TA01A - Fixed rod

The TA01A has no housing and is ideal for use in locations with limited space. Simple, economical and easy to assemble, this probe has single connection and 316 stainless steel rod with. The rod can be cut "on site", which makes it easily customizable to individual application requirements.

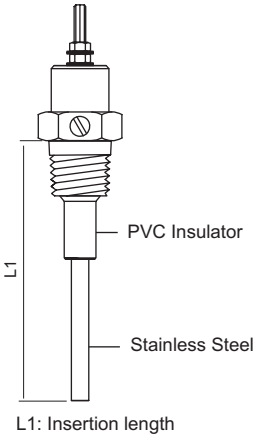

Models & Connections

Relay Controller BS-16

The BS-16 level controller is designed to be used in conjunction with the Sitron's Conductive Level Probes. The electrodes operate on alternating current, preventing the corrosion of the probes and the electrolytic decomposition of the product. The BS16 controls the differential between minimum and maximum with a relay output. It has adjustable sensitivity of 50K or 100K ohm's (optional model) used in liquid with low conductivity and adjustable timing from 0 to 5 seconds

Electrical Connections

1-
2- } Conductive Probe Input
3- }

6- Contact NO
7- Common
8- Contact NC

15- Power Supply(+) (~)
16- Power Supply(-) (~)

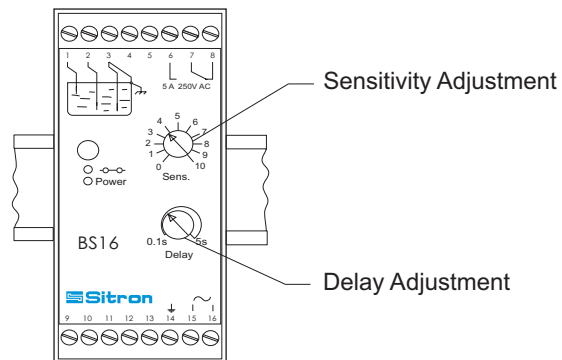

Application

Differential level control using the metallic tank as reference

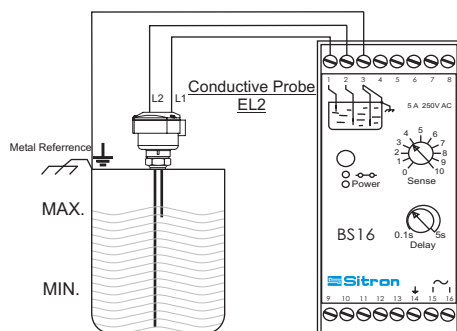

Differential level control using a third rod as reference

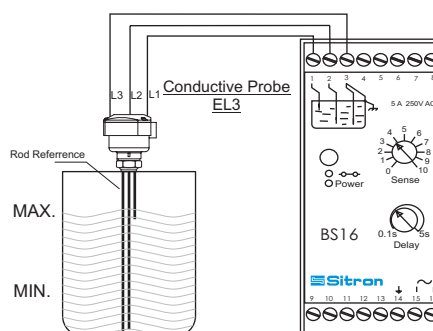

Models & Connections

Relay Controller BS-40

The BS-40 level controller is designed to be used in conjunction with Sitron's Conductive Level Probe. The electrodes operate on alternating current, preventing the corrosion of the probes and the electrolytic decomposition of the product. The BS40 controls the differential between minimum and maximum with relay output (SPDT). It has adjustable internal sensitivity of 50K or 100K ohm's (optional model) for applications in liquids with low conductivity.

Electrical Connections

1-
2- } Probe input
3- }

6- Contact NO
7- Common
8- Contact NC

15- Power Supply (+) (~)
16- Power Supply (-) (~)

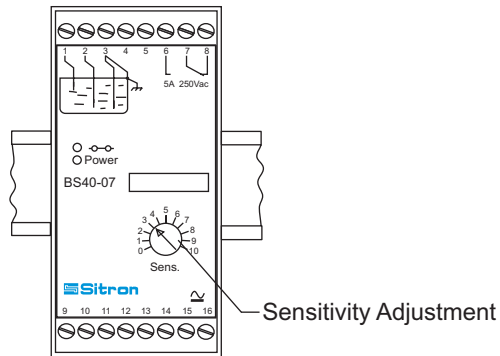

Application

Differential level control using the metallic tank as reference

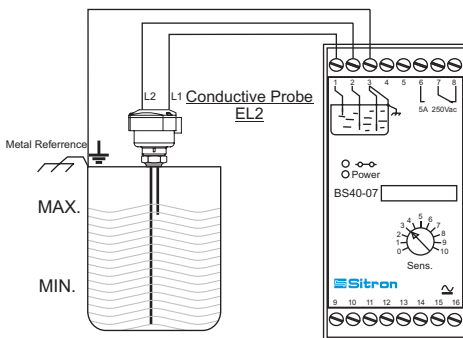

Differential level control using a third rod as reference

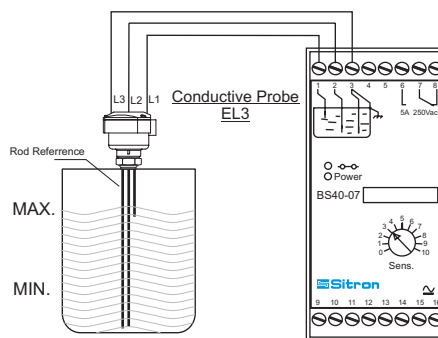

Models & Connections

Relay Controller CN-16

The CN-16 relay level is designed to be used in conjunction with Sitron's Conductive Level Probes. The electrodes operate on alternating current, preventing the corrosion of the probes and the electrolytic decomposition of the product. The CN-16 detects up to two independent levels, with relay output (SPDT 1) for each level. It has adjustable internal sensitivity of 50K or 100K ohms (optional model) for applications in liquids with low conductivity.

Electrical Connections

- 1- Conductive Probe Input
- 2- Conductive Probe Input
- 3- Conductive Probe Input
- 4- Conductive Probe Input
- 6- Contact NO
- 7- Common
- 8- Contact NC
- 9- Contact NO
- 10- Common
- 11- Contact NC
- 15- Power Supply (+) (~)
- 16- Power Supply (-) (~)

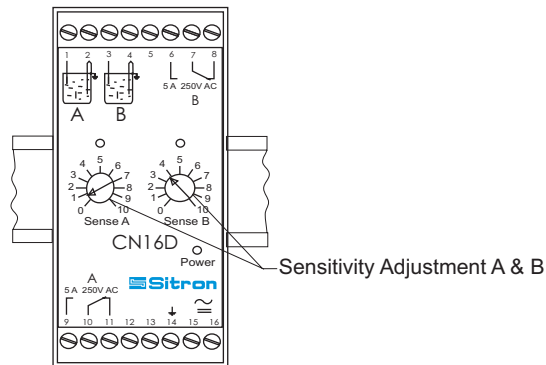

Application

Level control using the metallic tank as reference

Level control using a second rod as reference

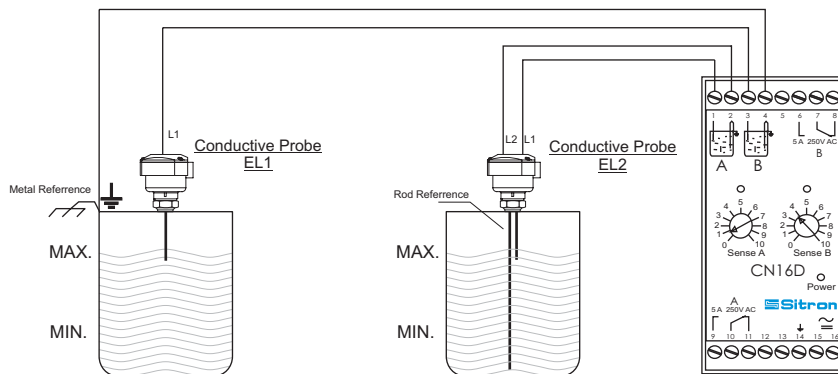

Models & Connections

Relay Controller CN-7

The CN-7 relay level is designed to be used in conjunction with the Sitron's EL Series of conductive probes. The electrodes operate with alternating current, preventing the corrosion of the probe and the electrolytic decomposition of the product. The CN-7 detects up to three independent levels, with (3X SPDT) relay outputs.

Electrical Connections

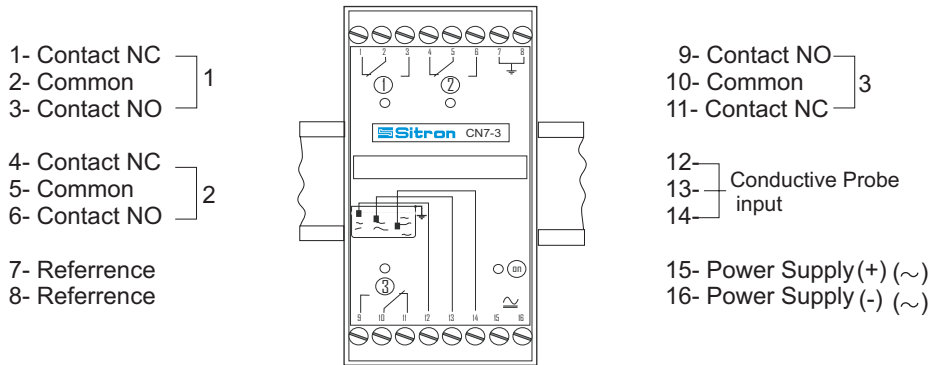

Application

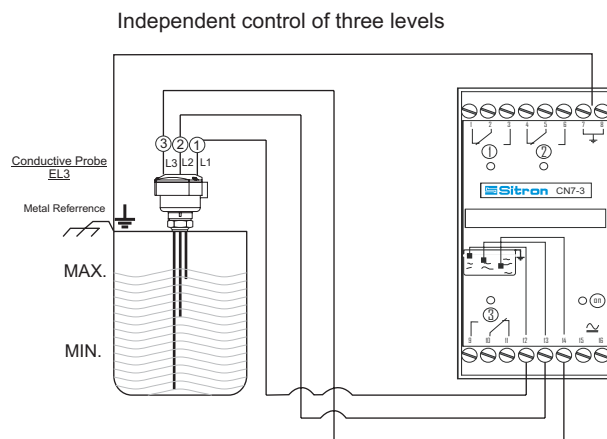

Amplifier Control CLD2

The amplifier control CLD2 relay can control minimum and maximum levels. For example, buoys or similar contacts to be connected to the line LP working satisfactorily until an external resistance of 10K ohm's.

The CLD2 has three important functions:

1. Relieve the overload on contacts avoiding arches during the ligament and shutdown.
2. Prevent vibration electrical switching contacts.
3. Transformation of the command values in higher power (5A/250V).
4. Control buoys to long distance

Electrical Connections

- 1- Probe
- 2- Probe
- 3- Reference

- 6- Contact NO
- 7- Common
- 8- Contact NC

- 15- Power Supply (+) (~)
- 16- Power Supply (-) (~)

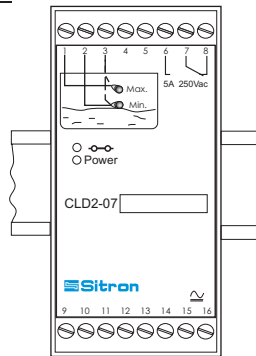

Application

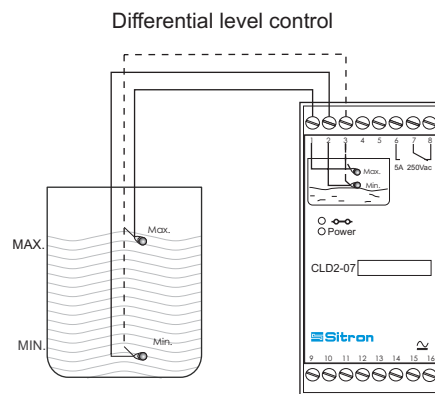

Mounting Notes

When making connections between the controller and the probe use reliable cables and make sure they are grounded.

Shielded cables prevent interference improving and protecting against false measurements.

To avoid radio frequency interference and possible malfunction. When possible, keep hand held communication equipment away from the Controller. If this unavoidable make a metal shield around the controller and confirm that the unit has been properly grounded.

Verify that the operating pressure and temperature of the process corresponds to the operating parameters of the probe.

Do not install the controller in harsh environments and humidity. Respect class protection, working temperature and protect the same from rain and excessive heat.

A stable Power Supply prevents damage and equipment malfunction.

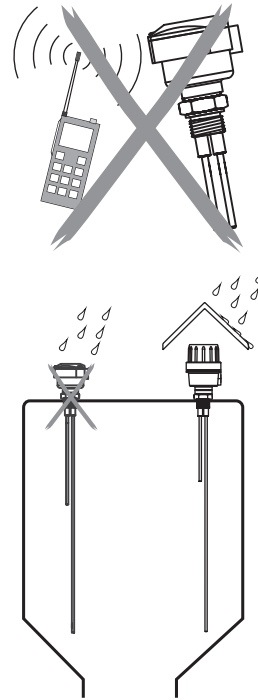

Controller Mounting

Panel mounting with the protection cover

A- DIN rail (35mm)

B- Screws

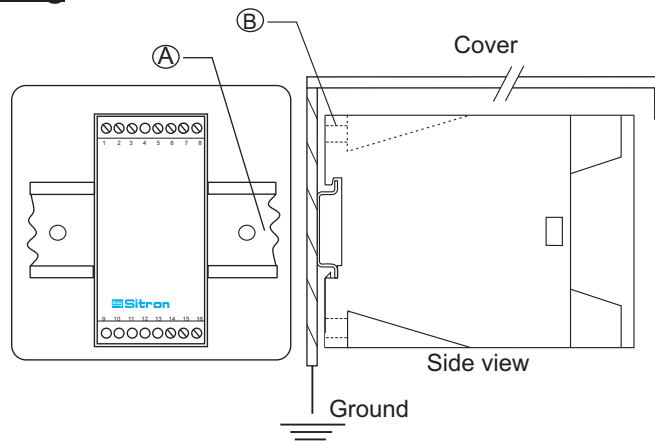

Installation

The probes may be installed in tanks or containers made of various materials such as metal, plastic, concrete etc.. For non-metallic tanks make sure that the probe has a reference rod (Fig. 1)

The metallic tank can be used as a reference (Fig. 2)

Evaluate the type of product to be detected in the process. The probes may require coating to protect the rod against high temperature from the liquid, steam, corrosive or aggressive products. (Fig.2)

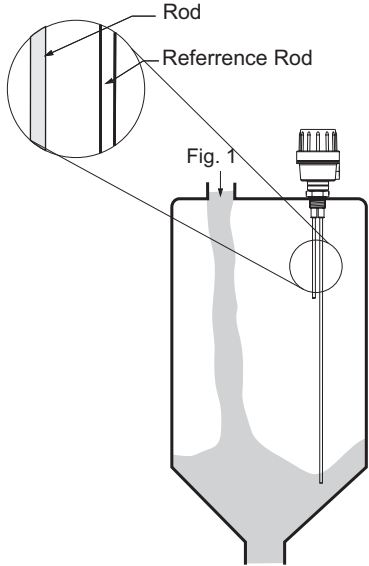

The threaded connection should be in contact with the metallic Tank

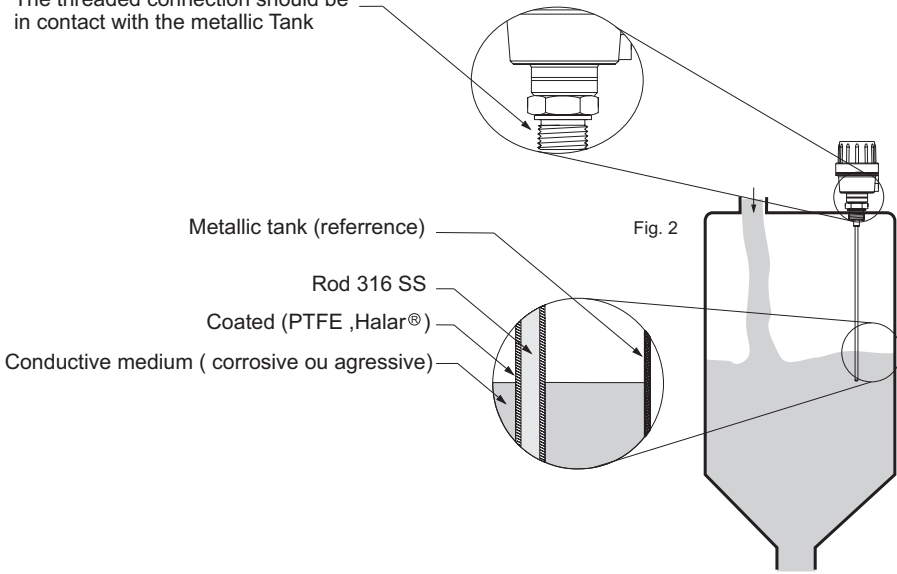

Installation

Verify that the location the probe is to be mounted is clear from the stream of product (Fig. 1).

Material falling onto the probe can cause damage or switching errors. If this is unavoidable, it is recommended that a protective shield be installed above the probe to protect it. The shield is also recommended when the probe is used for a low level switch or in the outflow of the product (Fig. 2).

The tip of the probe should slightly point downward (when possible) so that if there are any excess of product it will easily slide from the probe (Fig. 2).

When installing from the top of the tank confirm that the tip of the probe has cleared the side of the vessel at least 500mm (Fig. 3).

When installing the sensor directly to the tank make sure that the rod extends beyond the inner wall of the tank, by as much as possible, so that internal build up or other debris does not interfere with the sensor's performance (Fig. 2 correct Fig. 4 incorrect).

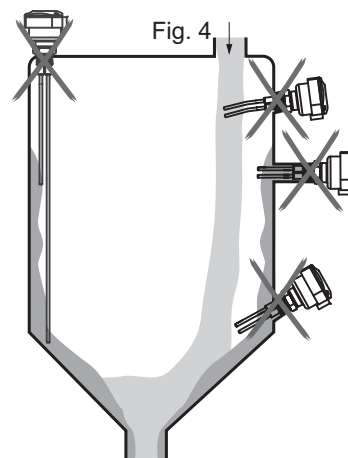
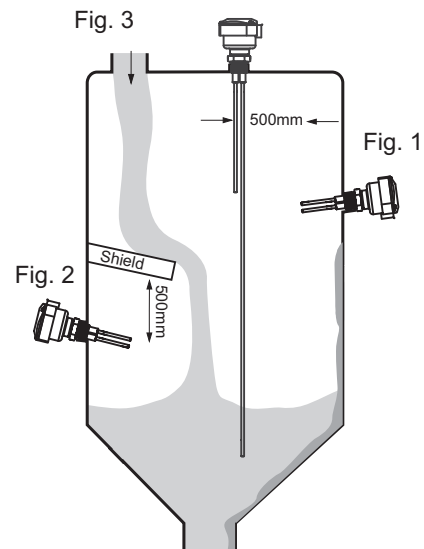

Installation

For probes with cable extensions, installation should be from the top of the tank. It is also recommended that for these probes the process shouldn't have any agitation as this can cause errors readings or damage to the probe (Fig. 5).

The EL with fixed rod is recommended for applications that have turbulence or vortices throughout use (Fig.6)

Ensure that the conduit is facing downward to avoid water from entering the housing (Fig. 7).

The probe must be installed utilizing the type of connection provided.

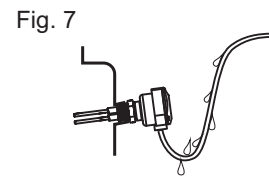
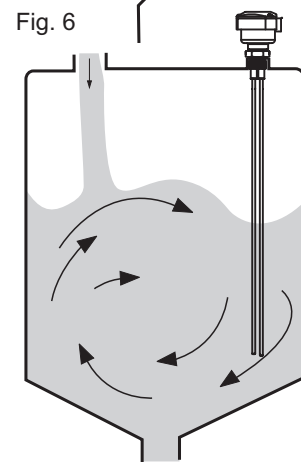
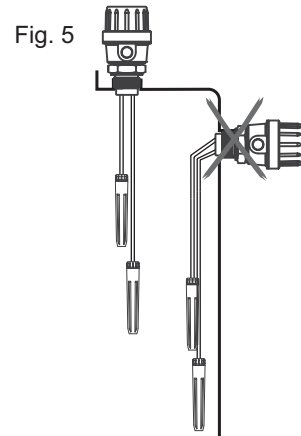

Technical Especifications

Relay Level Controller	
Model	CLD2

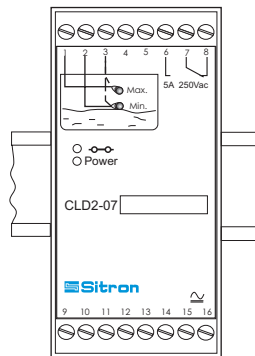

Application	Amplifier Control
Power Supply	110 or 220Vac (50/60Hz)
Consumption	2VA
Output	Relay (SPDT) 5A - 250Vac
Ajustment	—
Work Temperatue	-10 to +60°C
Enclosure	ABS (Resistant Thermoplastic)
Fixation	2 Screws or DIN rail 35mm
Class Protection	IP 40

Technical Especifications

Relay Level Controller		
Models	BS40	BS16

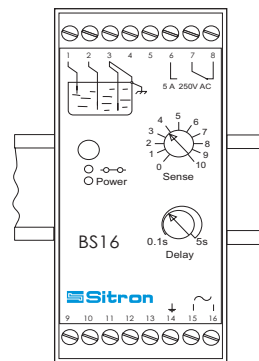
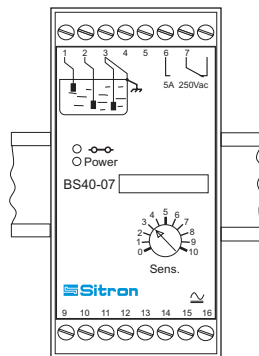

Application	Differential Level Controller Min. and Max. for Conductive Probes	Differential Level Controller Min. and Max. for Conductive Probes
Power Supply	110 or 220Vac (50/60Hz)	DC: 12Vdc or 24Vdc (50/60Hz); AC: 85... 240Vac (50/60Hz)
Consumption	2VA	2VA
Output	Relay (SPDT) 5A - 250Vac	Relay (SPDT) 5A - 250Vac or 1NO+1NC (BS16 AC)
Ajustment	Sensitivity: max. 50K Ω	Sensitivity: max. 50K Ω Time Delay
Work Temperature	-10 to +60°C	-10 to +60°C
Enclosure	ABS (Resistant Thermoplastic)	ABS (Resistant Thermoplastic)
Fixation	2 Screws or DIN rail 35mm	2 Screws or DIN rail 35mm
Class Protection	IP 40	IP 40

Technical Specification

Relay Level Controller

Models	CN7	CN16
--------	-----	------

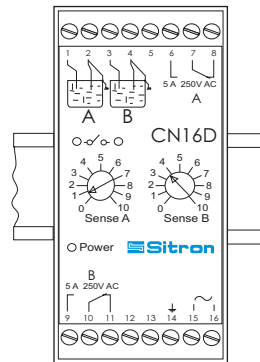
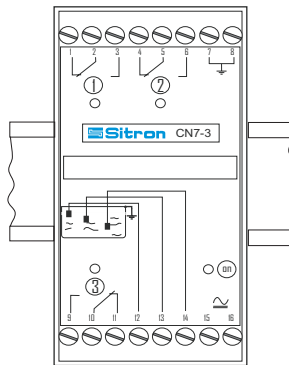

Application	Control of 3 Independent Level Points for Conductive Probe	Control of 2 Independent Level Points for Conductive Probe
Power Supply	DC: 24Vdc AC: 110 or 220Vac (50/60Hz)	DC: 24Vdc or AC: 85 to 240Vac (50/60Hz)
Consumption	1VA	3VA
Output	Relay (3 SPDT) 5A - 250Vac	Relay (2 SPDT) 5A - 250Vac
Adjustment	—	Sensitivity: max. 50K Ω
Work Temperature	-10 to +60°C	-10 to +60°C
Enclosure	ABS (Resistant Thermoplastic)	ABS (Resistente Thermoplastic)
Fixation	2 Screws or DIN rail 35mm	2 Screws or DIN rail 35mm
Class Protection	IP 40	IP 40

Technical Specification

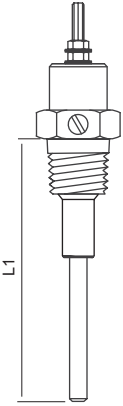
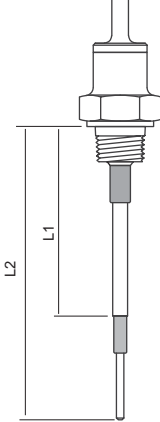
Conductive Probe		
	TA01	ER02
		
Application	Level Detection for Conductive Liquids	Level Detection for Conductive Liquids
Electrical Connection	Screw and Nut	Cable with 2000mm
Process Connection	1/2" to 1 1/2" BSP or NPT	1/2" or 3/4" BSP or NPT
Wetted Parts	Stainless Steel 316SS	Stainless Steel 316SS
Work Temperature	-10 to +80°C	-10 to +80°C
Max. Pressure	20 bar	10 bar
Class Protection	IP 40	IP 65

Technical Specification

EL- Conductive Probe

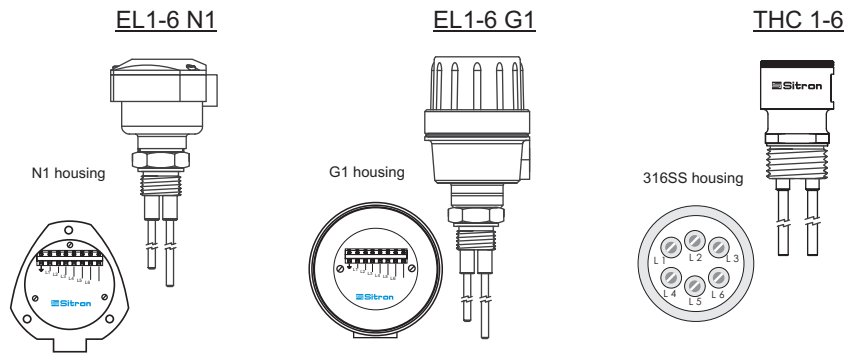

MODELS	1 Rod L1	2 Rods L2	3 Rods L3	4 Rods L4	5 and 6 Rods L5/L6
Application	Level Detection for Conductive Liquids	Level Detection for Conductive Liquids	Level Detection for Conductive Liquids	Level Detection for Conductive Liquids	Level Detection for Conductive Liquids
Housing	Nylon or Aluminum 316SS (THC)	Nylon or Aluminum 316SS (THC)	Nylon or Aluminum 316SS (THC)	Nylon or Aluminum 316SS (THC)	Nylon or Aluminum 316SS (THC)
Electrical Connection	Cable Gland ½" BSP or NPT	Cable Gland ½" BSP or NPT	Cable Gland ½" BSP or NPT	Cable Gland ½" BSP or NPT	Cable Gland ½" BSP or NPT
Process Connection	1/2" to 1 ½" BSP or NPT, flange or sanitary	3/4" to 1 ½" BSP or NPT, flange or sanitary	1" to 1 ½" BSP or NPT, flange or sanitary	1 ½" BSP or NPT, flange or sanitary	2" BSP or NPT, flange or sanitary
Work Temperature	-10° to 150°C	-10° to 150°C	-10° to 150°C	-10° to 150°C	-10° to 150°C
Max. Pressure	20 bar	20 bar	20 bar	20 bar	20 bar
Class Protection	IP 65	IP 65	IP 65	IP 65	IP 65

Technical Specification

EL -Conductive Probe

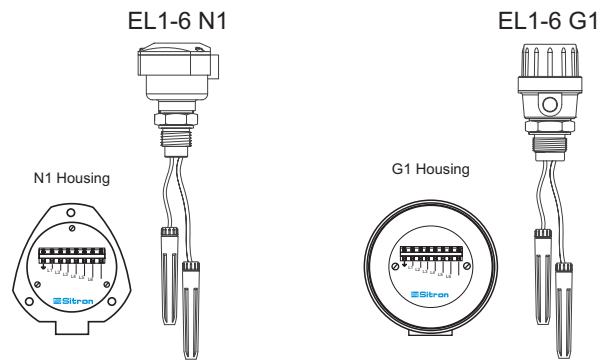

MODELS	electrode L1	electrode L2	electrode L3	electrode L4	L5 and L6 electrode
Application	Level Detection for Conductive Liquids	Level Detection for Conductive Liquids	Level Detection for Conductive Liquids	Level Detection for Conductive Liquids	Level Detection for Conductive Liquids
Housing	Nylon or Aluminum	Nylon or Aluminum	Nylon or Aluminum	Nylon or Aluminum	Nylon or Aluminum
Electrical Connection	Cable Gland ½" BSP or NPT	Cable Gland ½" BSP or NPT	Cable Gland ½" BSP or NPT	Cable Gland ½" BSP or NPT	Cable Gland ½" BSP or NPT
Process Connection	1/2" to 1 ½" BSP or NPT, flange or sanitary	3/4" to 1 ½" BSP or NPT, flange or sanitary	1" to 1 ½" BSP or NPT, flange or sanitary	1 ½" BSP or NPT, flange or sanitary	2" BSP or NPT, flange or sanitary
Work Temperature	-10° to 150°C	-10° to 150°C	-10° to 150°C	-10° to 150°C	-10° to 150°C
Max. Pressure	20 bar	20 bar	20 bar	20 bar	20 bar
Class Protection	IP 65	IP 65	IP 65	IP 65	IP 65

Handling & Maintenance

Seal the thread with Teflon tape before installation (Fig. 1).

Fig. 1

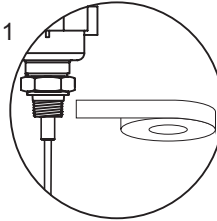

Do not turn or handle by the housing (Fig. 2).

Fig. 2

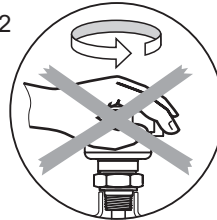

When tightening the sensor, use only use the 316S.S. hexagon fitting to achieve a seal, do not twist with the body of the sensor. (Fig. 3)

Fig. 3

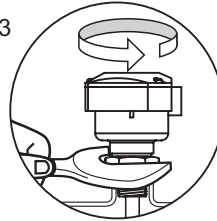

The probe should not be dropped or suffer any impact or fall that could damage the electronics or the coating of the probe (Fig. 4 and 5).

Periodic visual inspection of the probe is required to check for corrosion or deposit build-up. If deposits are found, clean the sensor to ensure optimum performance.

Fig. 4

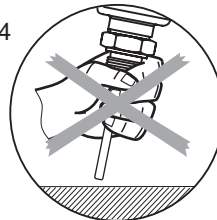

Care should be taken when handling and installing probes with coated rods to avoid scratching them. Scratching the coating could interfere with the probe performance.

Fig. 5

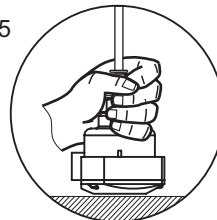

When cleaning the rod use a soft brush.

Trouble Shooting

Fail	Cause	Solution
Relay does not Work	LED of Power Supply indication does not turn On	Check the power supply
	Led of level indication does not turn On	Check cable resistance (max. must be 50kΩ)
		Check the sensibility adjustment.
Relay always On	LED ON	Check the sensibility adjustment.
	LED ON	Check the temperature of the medium. If there is steam present, coated rods should be used.
	LED ON	Check if there is build up on the rod.

Ordering Information

MODEL	
EL	SIZE
	0 NONE
	3 1/2"
	4 3/4"
	5 1"
	6 1 1/2"
	7 2"
	8 2 1/2"
	9 3"
	A 1 1/4"
	B M30(E)
	C 4"
	X OTHER
	PROCESS CONNECTION TYPE
	B BSP
	D FLANGE ANSI 150# CARBON STEEL PAINTED
	E FLANGE ANSI 150# 316 SS
	F FLANGE ANSI 150# - PVC
	M METRIC THREAD
	K FLANGE ANSI 150# - 304 SS
	N NPT
	R SMS FEMALE
	S SMS MALE
	T TRI CLAMP
	U NK25 (1/2" BSP)
	Y FEMALE DIN
	X OTHER SPECIFY
	TYPE OF ROD OR CABLE
	O NONE
	A FIXED ROD 1/4" - 316 SS
	L REMOVABLE ROD 1/4" - 316 SS
	N PVC CABLE
	S SILICON CABLE 2.5mm
	U REFERENCE CABLE 5/32" - 316 SS
	X OTHER
	COATING
	S NONE
	E EPOXY (up to 120°C)
	H COATED HALLAR (up to 150°C)
	N NYLON
	P PEEK (up to 260°C)
	X OTHER SPECIFY
	INSERTION LENGTH
	L SPECIFY
	HOUSING
	SC NO HOUSING
	A1 STAINLESS STEEL
	N1 SMALL NYLON
	G1 SMALL ALUMINIUM
	GE G1, ENCAPSULED
	ELECTRICAL CONNECTION
	1 1/2" BSP (N1 OR G1)
	2 CABLE GLAND W/ 1/2" BSP
	3 3/4" BSP (G1)
	5 CABLE GLAND W/ 3/4" BSP (G1)
	6 1/2" NPT (N1 OR G1)
	7 CABLE GLAND W/ 1/2" NPT
	8 1/2" NPT CABLE GLAND & 2m CABLE
	9 3/4" NPT (G1)
	S CLIMPED W/ 2m OF CABLE (EL - SC)
	T POTTED W/ 2m PVC CABLE (ER02)
	Y CABLE GLAND W/ M16 METAL (A1)
	OPTIONS
	O NONE
	A CLAMP
	E SINGLE ELECTRODE IN A POLIPROPELENE ENCLOSURE
	F O'RING
	C REFERENCE SHEATH
	MT MEDIUM TEMPERATURE - 50mm 316 SS NECK (80-120°C)
	AT HIGH TEMPERATURE - 100mm 316 SS NECK (80-150°C)
	L ADAPTOR
	N NIPPLE FOR NK25 (1/2" BSP)
	Q SS 304
	S SANITARY NIPPLE
	T LOCKING NUT

Ordering Information

MODELS	RELAY CONTROLLER
BS/40-11	MIN.MAX. LEVEL (1SPDT) - 115 VAC (50/60 Hz)
BS/40-23	MIN.MAX. LEVEL (1SPDT) - 230 VAC (50/60 Hz)
BS/16-24	MIN.MAX. LEVEL (1SPDT) - 24VDC +/- 10%
BS/16-11	MIN.MAX. LEVEL (1SPDT) - 115 VAC (50/60 Hz)
BS/16-12	MIN.MAX. LEVEL (1SPDT) - 12VDC +/- 10%
BS/16-23	MIN.MAX. LEVEL (1SPDT) - 230 VAC (50/60 Hz)
BS/16-85	UNIVERSAL POWER (24VDC +/- 10% or 85 to 240 VAC, 50/60 Hz)
CLD2-11	AMPLIFIER CONTROL (115 VAC, 50/60 Hz)
CLD2-23	AMPLIFIER CONTROL (230 VAC, 50/60 Hz)
CN/16-24	2 DIFF. LEVEL (2 SPDT) - 24 VDC +/- 10%
CN/16-11	2 DIFF. LEVEL (2 SPDT) - 115 VAC (50/60 Hz)
CN/16-23	2 DIFF. LEVEL (2 SPDT) - 230 VAC (50/60 Hz)
CN/16-24 DI	2 DIFF. LEVEL (2 SPDT) W/ FAIL SAFE PROTECTION - 24 VDC +/- 10%
CN/16-11 DI	2 DIFF. LEVEL (2 SPDT) W/ FAIL SAFE PROTECTION - 115 VAC (50/60Hz)
CN/16-23 DI	2 DIFF. LEVEL (2 SPDT) W/ FAIL SAFE PROTECTION - 230 VAC (50/60Hz)



Terms & Conditions

Sitron's TERMS & CONDITIONS

Design: Sitron reserves the right to make any alterations or changes necessary to improve the Products, correct defects or to make the Products safer, without prior notice or consent by Buyer.

Pricing: All stipulated amounts shall be in US dollars and all prices quoted are valid for thirty (30) days from date of offer, unless otherwise stated.

Safety and Instructions: The Buyer ensures that it and all its representatives and agents will observe all safety and technical instructions in Sitron's operating manuals, catalogs or other directions or instructions (either written or verbal).

Delivery and Freight: All goods are sold FOB point of shipment, Brasil. Transportation to the destination is the Buyer's responsibility and Buyer alone shall bear the cost of freight, optional or other shipping requirements, and or insurance. Sitron shall not be liable for loss or damage to the Products after said Products are delivered to or received by the shipper/carrier, and all risk of damage or loss shall immediately pass to Buyer.

Receiving, unloading and storing of Products will be the responsibility of the Buyer.

Buyer also accepts that courier may choose to return Products to Sitron if any local taxes or duties are not paid by Buyer at point of delivery. Buyer must make any and all claims for corrections or deductions within ten days of the delivery of the Products.

Shipment Delays: Sitron has no control over the length of time shipments may be held at customs, etc. For this reason, Sitron commits only to a "shipment date", not a "delivery date". Buyer shall not hold Sitron liable for claims resulting from delay in shipment except in cases where these terms are accepted in writing by Sitron. Acceptance of delivery of Products by Buyer shall constitute a waiver of all claims for delay.

Partial Deliveries: While Sitron strives to deliver all orders on time and complete, Sitron reserves the right to make partial deliveries when necessary.

Changes: Any changes initiated by the Buyer which affects the products specifications; quantities ordered; delivery schedule; method of shipment or packing; or delivery location, must be made in writing and signed by both parties.

In this case, Sitron reserves the right to adjust the pricing and or delivery of the order, which will be agreed to by both parties before further work is performed on the order. Any such requests will be priced according to the scope of changes and the status of the current order. Customer must sign and return or acknowledge approval of drawings along with any Purchase Order. If approval drawings are not returned with order, the delivery date may be held or pushed back until Customer has acknowledged approval.

Cancellation: Any cancellation of the Contract by the Buyer shall be effective only if made in writing and accepted, in writing by the Sitron. In such a case, Sitron is entitled to reasonable cancellation charges including but not limited to labor, material and other related expenses.

Terms & Conditions

Termination Fee Schedule:

Order entered but not released for manufacturing	10%
Order in any stage of production	75%
Order complete and ready for shipment	100%

Warranty: Sitron warrants its product against manufacturing defects in material and workmanship, when installed in applications approved by Sitron, for a period of one year from the date of original shipment, unless otherwise stated in writing by Sitron.

Sitron is not responsible for damage to Sitron's Products or other equipment or products because of improper installation or misapplication of the Products by Buyer. Installation or startup of Sitron's equipment must be performed under the guidelines set forth in Sitron's instruction manuals, wiring diagrams, etc., or performed under the direct supervision of Sitron's field technicians or Sitron's authorized Sales Representatives, in order to be covered by Sitron's warranty.

Sitron shall be under no liability in respect to any defect from fair wear and tear, willful damage, negligence, abnormal working conditions, failure to follow Sitron's instructions (whether written or verbal), misuse, modification or alteration or attempted repair of the Goods without Sitron's approval.

Sitron shall not be liable under the above warranty (or any other warranty, condition or guarantee) if the total price for the Products or the payment of Services rendered has not been paid by the due date for payment.

The Buyer must make all tools, resources or personnel available to help Sitron to diagnose the defect without any back charge. In absence of Buyer's cooperation in this regard, there shall be no liability under the above Warranty.

Sitron's liability under this warranty shall be limited to repair or replacement at Sitron's option of such defective Products, FOB factory, upon proof of defect satisfactory to Sitron. Warranty does not include transport.

Return Goods: No goods may be returned without Sitron's permission and an RMA number. Sitron assumes no responsibility for return shipments made without permission. In issuing credit for such shipments, Sitron reserves the right to charge a restocking fee dependent on Sitron's ability to recondition and resell the returned equipment.

Insurance: The responsibility for insuring the Goods after the risk in them has passed to the Buyer shall be that of the Buyer.

Confidential Information: All drawings, specifications, and technical information provided by either Buyer or Sitron shall be treated as confidential and shall not be disclosed to anyone other than those who require it as part of the fulfillment of the order. Buyer agrees that the designs and/or any other related material provided are and remain Sitron's exclusive property and that the Buyer acquires no right, title or interest to this intellectual property, whether in whole or in part.

Errors: Sitron reserves the right to correct all typographical or clerical errors or omissions, in its prices or specifications.



Sitron - Brasil
R. Baronesa de Itu, 83
São Paulo - SP - 01231-001
T: (5511) 3825-2111
F: (5511) 3825-2171

Sitron - USA
1800 Prime Place
Hauppauge, NY 11788
PH: 516-935-8001
FX: 800-516-1656

www.sitron.com
BRASIL: vendas@sitron.com
USA / Other Countries: info@sitron.com